

# ISCAR PROMOTIONS

Valid until September 30th, 2026

Inch Version

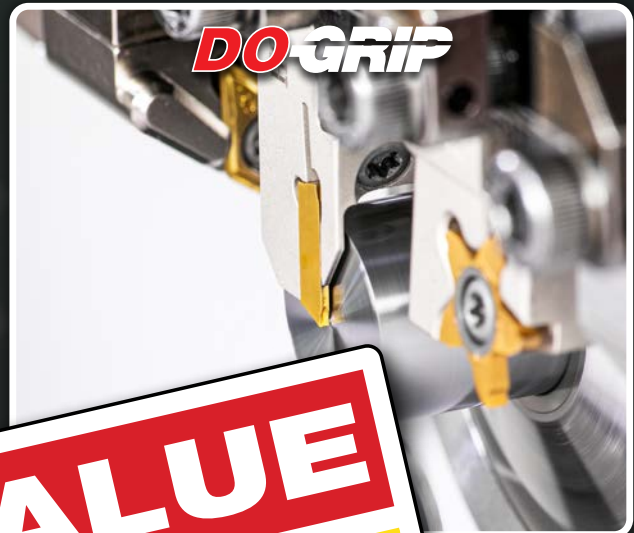

**MAX VALUE**  
MINIMUM COST MAXIMUM OUTPUT



**MINIMUM COST**

**MAXIMUM OUTPUT**

**MORE** PERFORMANCE  
PRODUCTIVITY  
PROFITABILITY

**MAXVALUE**





This miniature, double-sided tangential insert with 4 cutting edges offers a **cost-effective solution for stable, accurate 90° milling at shallow depths.**

**YOU**

MACHINING

INTELLIGENTLY?

Use Promo Code: **T2800/1**

**1 Purchase**

20 inserts - T490 LNMT/HT 05/08... or T490 LNAR 08...\* same size any assortment

**Receive**

Corresponding T490 ELN...-05/08 endmill cutter up to 1.25"

**at a 60% Additional Discount**

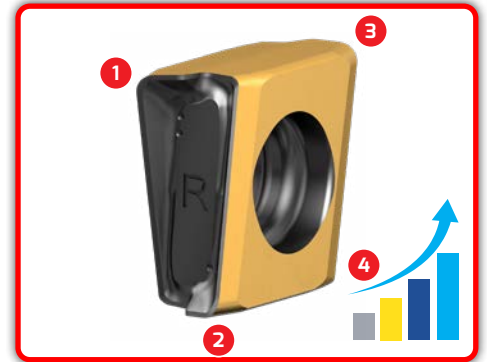

Use Promo Code: **T2800/1**

**2 Purchase**

40 inserts - T490 LNMT/HT 05/08... or T490 LNAR 08...\* same size any assortment

**Receive**

Corresponding T490 FLN...-05/08 face mill cutter up to 2.50"

**at a 60% Additional Discount**

**SPECIAL OFFER**

Use Promo Code: **T2800/1**

**3 Purchase**

40 inserts - T490 LNMT/HT 05 same size any assortment

**Receive**

Corresponding T490 FM...SP face mills with a SP connection up to 2.00"

**at a 60% Additional Discount**

\*T2800 = 05, T2801 = 08  
The image shown is for representational purposes.



**MAX VALUE**  
MINIMUM COST MAXIMUM OUTPUT



The ultimate all-in-one indexable tool, combining milling and drilling to **increase versatility, maximize insert utilization, and improve cost efficiency.**

**YOU**

**MACHINING**

**INTELLIGENTLY?**

Use Promo Code: **T2802/3/4/5**

## 1 Purchase

20 inserts - MDR ANMU/HU 07/09/12/16...\*  
same size any assortment

## Receive

Corresponding MDR D...-07/09/12/16  
endmill cutter up to 1.25"

**at a 60% Additional Discount**

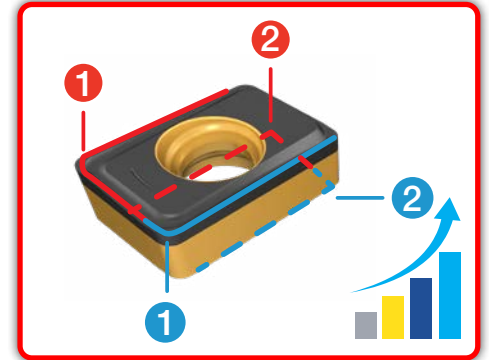

\*T2802 = 07, T2803 = 09, T2804 = 12, T2805 = 16  
The image shown is for representational purposes.



**MAXVALUE**

**MINIMUM COST MAXIMUM OUTPUT**



A smart, cost-saving solution for indexable face milling that delivers **greater part-making capability with fewer tools to stock** and the right tool for the job **with outstanding value and efficiency.**

**YOU**

**MACHINING**

**INTELLIGENTLY?**

Use Promo Code: **T2806**

**1 Purchase**

20 inserts - S845 SNMU/HU 13... or ONMU/HU 05... same size any assortment

**Receive**

Corresponding SOE45 8/16... endmill cutter up to 1.25"

**at a 60% Additional Discount**

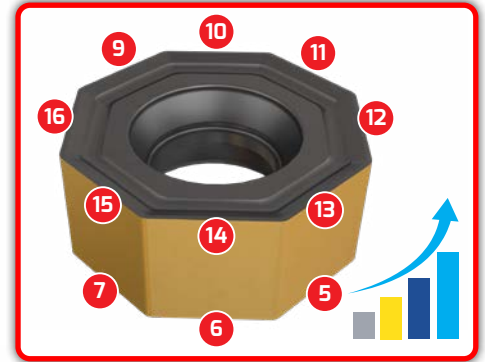

Use Promo Code: **T2806**

**2 Purchase**

40 inserts - S845 SNMU/HU 13... or ONMU/HU 05... same size any assortment

**Receive**

Corresponding SOF45 8/16... face mill cutter up to 5.00"

**at a 60% Additional Discount**

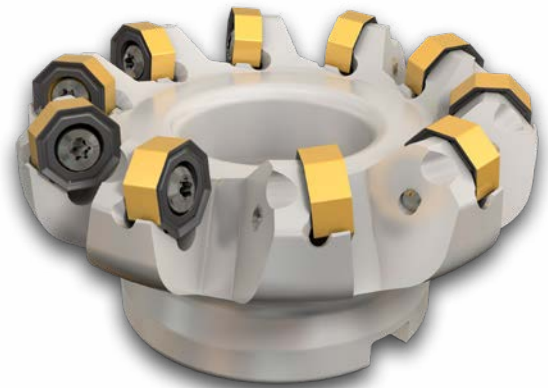

The image shown is for representational purposes.



**MAX VALUE**  
MINIMUM COST MAXIMUM OUTPUT



With 3 indexable cutting edges, the small high-feed trigon insert delivers **efficient, productive roughing** and proves that compact inserts can make a big performance impact.

**YOU**

MACHINING

INTELLIGENTLY?

Use Promo Code: **T2807**

## 1 Purchase

20 inserts - FFT3 WXMT 03... any assortment

## Receive

Corresponding FFT3 EFM D...-03 endmill cutter up to 1.00"

**at a 60% Additional Discount**

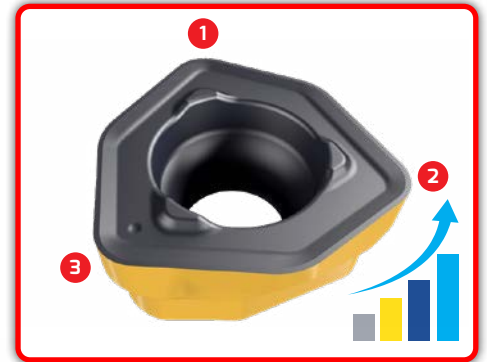

The image shown is for representational purposes.

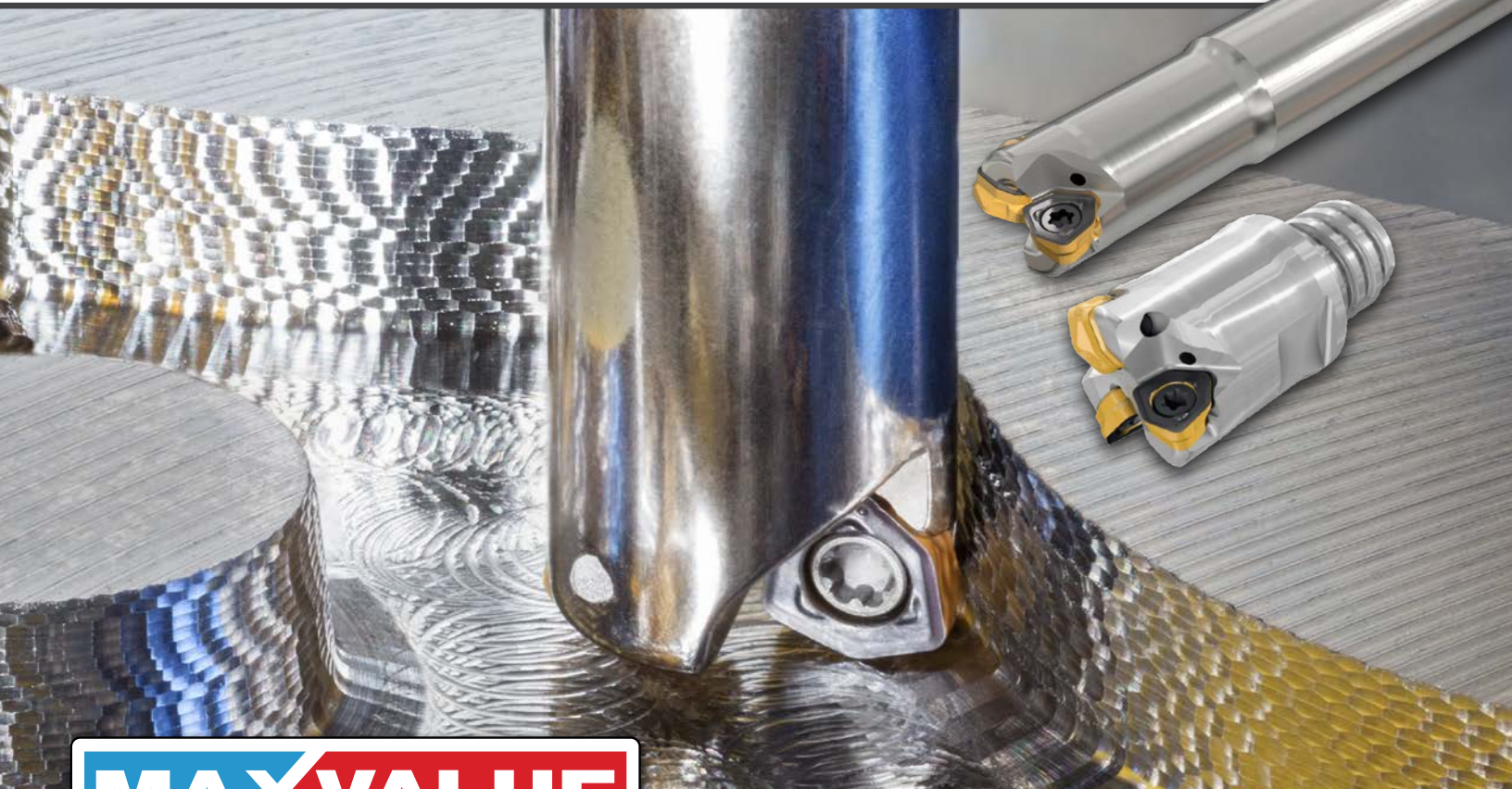

**MAXVALUE**

MINIMUM COST MAXIMUM OUTPUT



A material-efficient triangular insert with 3 cutting edges **boosts productivity through longer tool life, delivering accurate 90° square-shoulder milling while reducing carbide scrap through full-edge utilization.**

**YOU**

MACHINING

**INTELLIGENTLY?**

Use Promo Code: **T2808**

## 1 Purchase

20 inserts - HM390 TPKT/CT 05...- any assortment

## Receive

Corresponding HM390 ETP...-05  
endmill cutter up to .625"

**at a 60% Additional Discount**

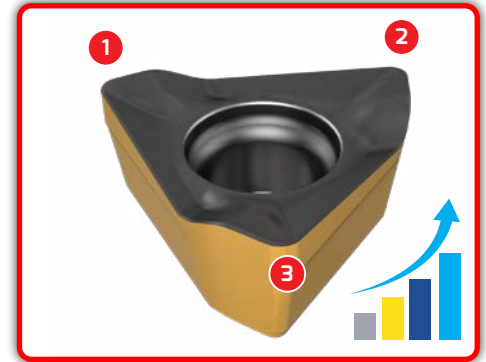

The image shown is for representational purposes.



**MAX VALUE**

**MINIMUM COST MAXIMUM OUTPUT**



With 4 cutting edges and a depth of cut of up to .315", this robust double-sided insert delivers a **high-productivity milling solution at an excellent cost per edge.**

**YOU**

MACHINING

INTELLIGENTLY?

Use Promo Code: **T2809**

**1 Purchase**

20 inserts - H490 ANKX/CX 09... same size any assortment

**Receive**

Corresponding H490 E90AX...-09 endmill cutter up to 1.25"

**at a 60% Additional Discount**

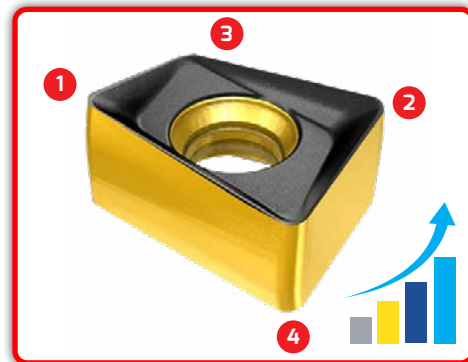

Use Promo Code: **T2809**

**2 Purchase**

40 inserts - H490 ANKX/CX 09... same size any assortment

**Receive**

Corresponding H490 F90AX...-09 face mill cutter up to 2.50"

**at a 60% Additional Discount**

The image shown is for representational purposes.

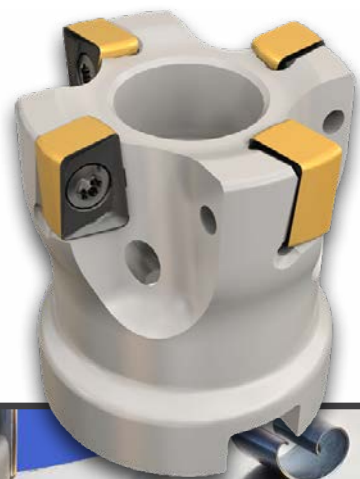

**MAX VALUE**  
MINIMUM COST MAXIMUM OUTPUT



With 4 indexable cutting edges, the small insert enables higher tooth density in high-feed milling cutters, **increasing productivity.**

**YOU**

MACHINING

**INTELLIGENTLY?**

Use Promo Code: **T2810**

## 1 Purchase

20 inserts - FFQ4 SOMT/W 06...  
same size any assortment

## Receive

Corresponding FFQ4 D...-06  
endmill cutter up to 1.25"

**at a 60% Additional Discount**

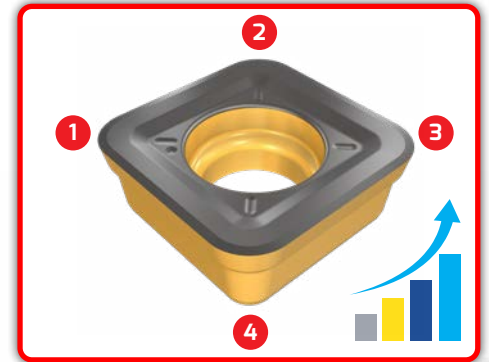

The image shown is for representational purposes.

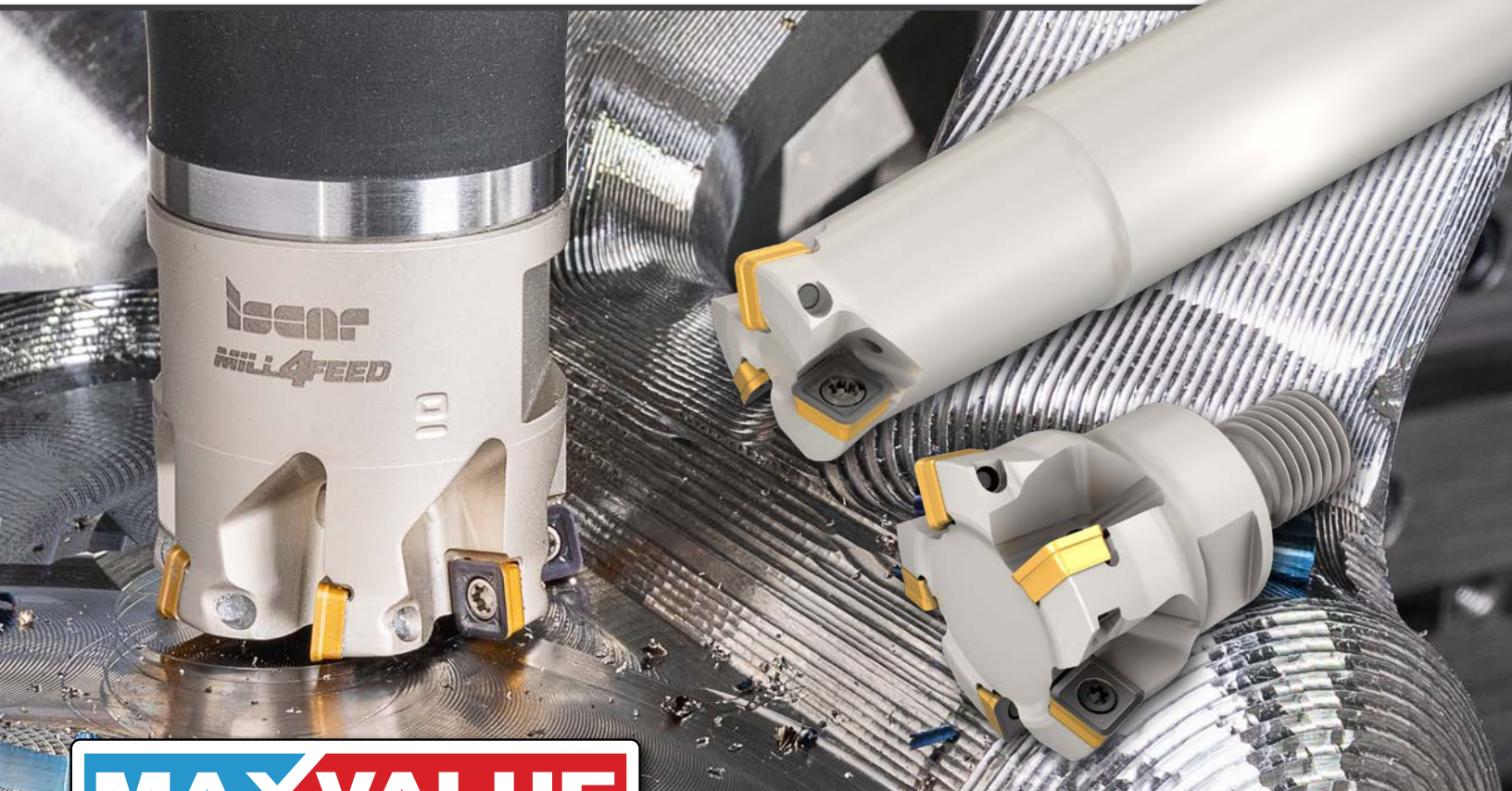

**MAX VALUE**

**MINIMUM COST MAXIMUM OUTPUT**



A full range of cost-efficient **MULTI-MASTER** tools with exchangeable cutting heads offers 40,000 solid carbide endmill combinations, delivering unmatched versatility for diverse machining applications. The **MULTI-MASTER** range enables efficient roughing and finishing, superior surface quality, and increased productivity across virtually any material.

**YOU**

**MACHINING**

**INTELLIGENTLY?**

Use Promo Code: **T2811**

## 1 Purchase

6 MULTI-MASTER solid carbide heads -  
up to .75" included  
same size any assortment

## Receive

Corresponding steel shank up to .75"\*

**Free of Charge**

\* Integral/CAMFIX shanks not included  
The image shown is for representational purposes.

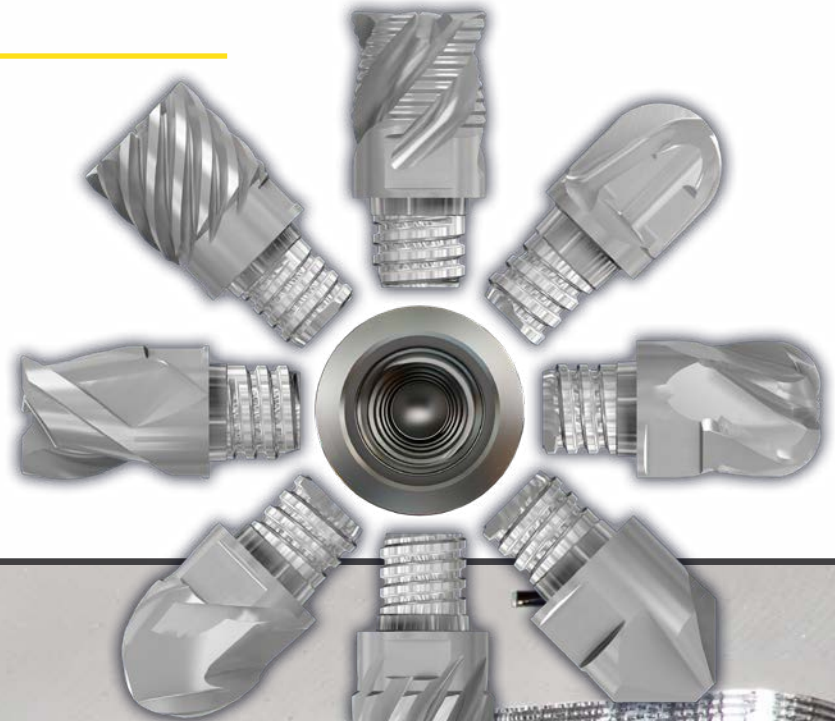

**MAXVALUE**

**MINIMUM COST MAXIMUM OUTPUT**



Exchangeable heads bring modular versatility to drilling, **lowering tooling costs, enabling productive performance across a wide range of materials, and reducing carbide scrap by replacing only the head instead of the entire tool.**

Use Promo Code: **T2812**

## 1 Purchase

4 drilling heads - ICP/HCP/ICK/ICM/QCP/FCP/IHP/ICN same size any assortment

### Receive

Corresponding DCN/DCNS/DCNM/DCNT/DCN...  
-MMT/DCN...-PICCO drill body up to 3XD up to 1.00"

**Free of Charge**

Use Promo Code: **T2812**

## 2 Purchase

6 drilling heads - ICP/HCP/ICK/ICM/QCP/FCP/IHP/ICN same size any assortment

### Receive

Corresponding DCN/DCNS/DCNM/DCNT/DCN...  
-MMT/DCN...-PICCO drill body 5XD up to 1.00"

**Free of Charge**

Use Promo Code: **T2812**

## 3 Purchase

8 drilling heads - ICP/HCP/ICK/ICM/QCP/FCP/IHP/ICN same size any assortment

### Receive

Corresponding DCN/DCNS/DCNM/DCNT/DCN...-MMT/DCN...-PICCO drill body 8XD up to 1.00"

**Free of Charge**

The image shown is for representational purposes.

**YOU**

MACHINING

INTELLIGENTLY?

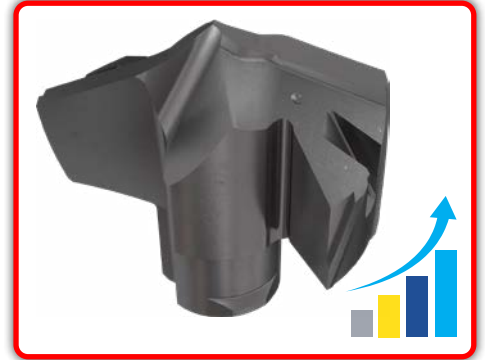

**SPECIAL OFFER**

**MAX VALUE**

**MINIMUM COST MAXIMUM OUTPUT**

# MULTI-FUNCTION TOOLS

Valid until September 30th, 2026



All-in-one multi-functional tool to increase efficiency and cut costs.

**YOU**

MACHINING

INTELLIGENTLY?

Use Promo Code: **T2813**

## 1 Purchase

30 inserts - XCMT...-MF / XCMT...-MG  
same size any assortment

## Receive

Corresponding DR-MF / DRG-MF... drill body

**at a 50% Additional Discount**

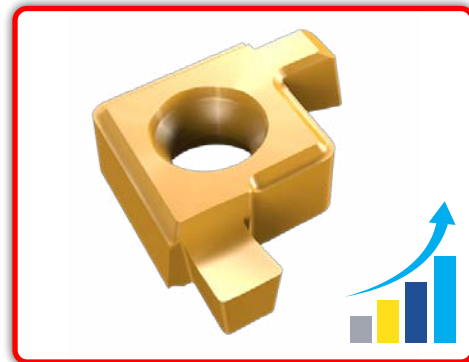

The image shown is for representational purposes.



**MAXVALUE**

MINIMUM COST MAXIMUM OUTPUT



**PICCO-INDEX** tools offer an economical choice for small-part machining, combining roughing, semi-finishing, and finishing capabilities with superior chip control and low costs.

**YOU**

**MACHINING**

**INTELLIGENTLY?**

Use Promo Code: **T2814**

## 1 Purchase

10 carbide inserts - CCGT 03 / WBMT 06 / WBGT 06 / CCGW 03 / CCMT 06 same size any assortment

### Receive

Corresponding PICIN... INDEX holder

**at a 50% Additional Discount**

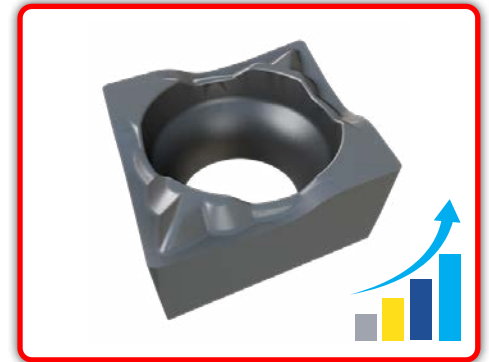

Use Promo Code: **T2814**

## 2 Purchase

2 CBN inserts - CCGT 03 / WBMT 06 / WBGT 06 / CCGW 03 / CCMT 06 same item

### Receive

Corresponding PICIN... INDEX holder

**at a 50% Additional Discount**

The image shown is for representational purposes.



**MAXVALUE**

**MINIMUM COST MAXIMUM OUTPUT**



**Maximize efficiency and minimize raw material waste** with narrow-cut inserts designed for parting and slitting.

**YOU**

**MACHINING**

**INTELLIGENTLY?**

Use Promo Code: **T2815**

**1 Purchase**

10 inserts - GFT 0.8../1.0../1.2... same size any assortment

**Receive**

Corresponding SGAQ blade

**at a 60% Additional Discount**

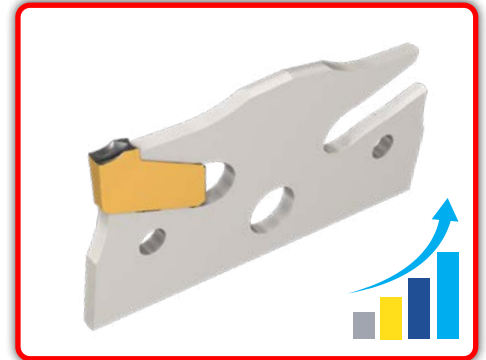

Use Promo Code: **T2815**

**2 Purchase**

30 inserts - GFT 0.8../1.0../1.2... same size any assortment

**Receive**

Corresponding SGST slitting cutter up to 2.50"

**at a 60% Additional Discount**

The image shown is for representational purposes.



**MAXVALUE**

**MINIMUM COST MAXIMUM OUTPUT**



With a durable pocket design and ultra-rigid clamping, the tool delivers **precise cuts, longer tool life, and maximum efficiency in parting, grooving, and slitting applications.**

Use Promo Code: **T2816**

**1 Purchase**

10 inserts - TAG 1.4 / 1.6 / 2.0  
same size any assortment

**Receive**

Corresponding TGFH / TGSU / TGTR / TGTL  
blade or integral holder

**at a 60% Additional Discount**

**YOU**

**MACHINING**

**INTELLIGENTLY?**

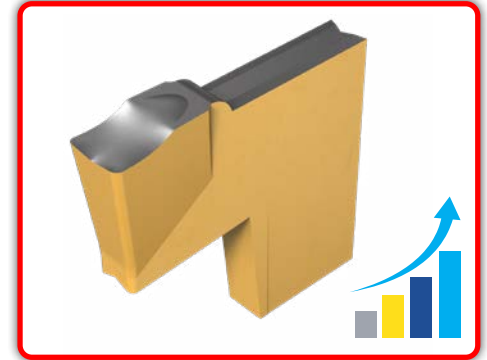

The image shown is for representational purposes.



**MAXVALUE**  
MINIMUM COST MAXIMUM OUTPUT



The double-sided insert is a **cost-effective solution for parting up to .866"** on Swiss-Type machines, with its narrow cutting widths **maximizing raw material savings.**

**YOU**

MACHINING

**INTELLIGENTLY?**

Use Promo Code: **T2817**

## 1 Purchase

10 narrow inserts - DGN 0.8 / 1.0 / 1.2  
same size any assortment

## Receive

Corresponding DGTR / DGTL / DG PAD / NQCH  
integral holder

**at a 60% Additional Discount**

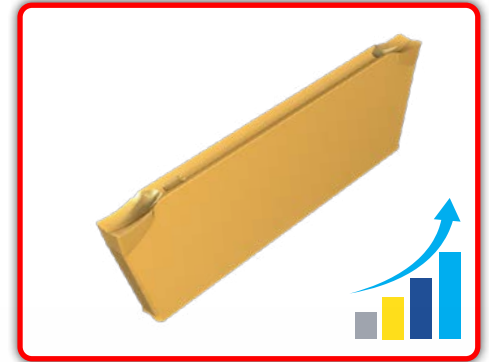

The image shown is for representational purposes.

**MAX VALUE**

**MINIMUM COST MAXIMUM OUTPUT**



The double-sided insert offers a **cost-effective solution for high-performance parting of larger diameters up to 2.4"**, with narrow cutting widths that maximize raw material savings.

**YOU**

MACHINING

INTELLIGENTLY?

Use Promo Code: **T2818**

## 1 Purchase

10 inserts - DGN/R/L 2...-XL  
same size any assortment

## Receive

Corresponding DGTR / DGTL  
integral holder

**at a 60% Additional Discount**

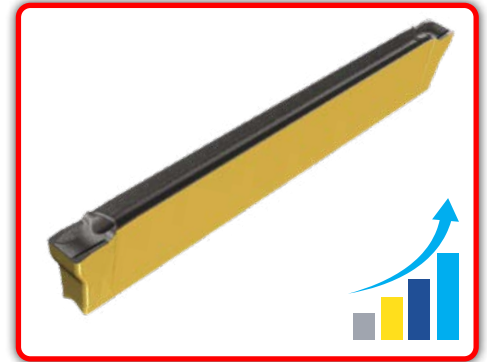

The image shown is for representational purposes.



**MAXVALUE**

MINIMUM COST MAXIMUM OUTPUT



The proven original cut-off solution for **significantly lower parting costs, backed by lasting performance and reliability.**

**YOU**

MACHINING

**INTELLIGENTLY?**

Use Promo Code: **T2819**

1

## Purchase

10 inserts - GFN 1.2 / 1.6 / 2.0  
same size any assortment

## Receive

Corresponding SGFH / SGTFR / SGTFL  
blade or integral holder

**at a 60% Additional Discount**

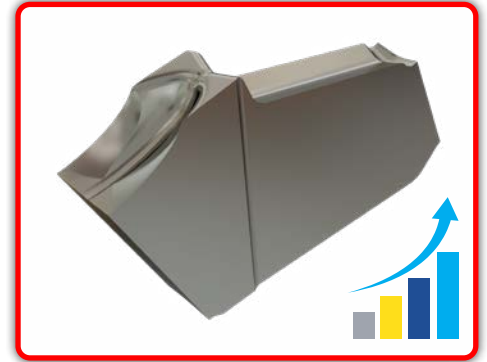

The image shown is for representational purposes.

**SPECIAL  
OFFER**

**MAXVALUE**

**MINIMUM COST MAXIMUM OUTPUT**



This robust 2 cutting edge insert, tangentially clamped for **superior stability**, delivers **longer tool life** and allows **narrow cutting widths** for **maximum raw material savings**.

**YOU**

MACHINING

INTELLIGENTLY?

Use Promo Code: **T2820**

## 1 Purchase

10 inserts - TGV...  
same size any assortment

## Receive

Corresponding TGVR/L ... holder

**at a 60% Additional Discount**

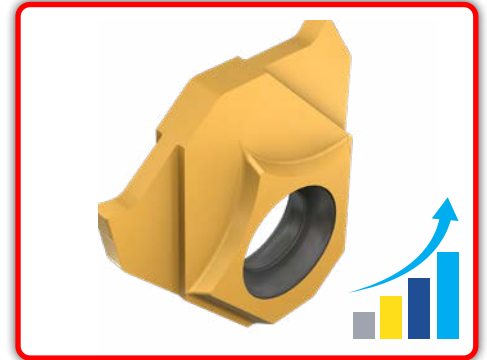

The image shown is for representational purposes.

**MAX VALUE**

MINIMUM COST MAXIMUM OUTPUT



Pentagonal inserts with 5 cutting edges offer a **cost-effective solution for grooving while minimizing raw material waste during parting operations.**

**YOU**

MACHINING

**INTELLIGENTLY?**

Use Promo Code: **T2821**

## 1 Purchase

5 inserts - PENTA 17...any assortment

## Receive

Corresponding PCHRS / PCHLS ... blade

**at a 60% Additional Discount**

**SPECIAL OFFER**

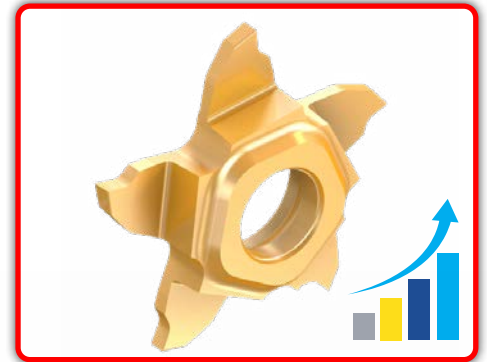

The image shown is for representational purposes.

**MAXVALUE**

**MINIMUM COST MAXIMUM OUTPUT**



The 80° design features double-sided, 4-edge CXMG inserts that replace 2-edge CCMT inserts. A dovetail pocket **enhances stability, extends tool life, and reduces cost per part on Swiss-Type and compact lathes.**

**YOU**

MACHINING

INTELLIGENTLY?

Use Promo Code: **T2822**

## 1 Purchase

20 inserts - CXMU / CXGU 06...any assortment

## Receive

Corresponding tool holder\*

**at a 50% Additional Discount**

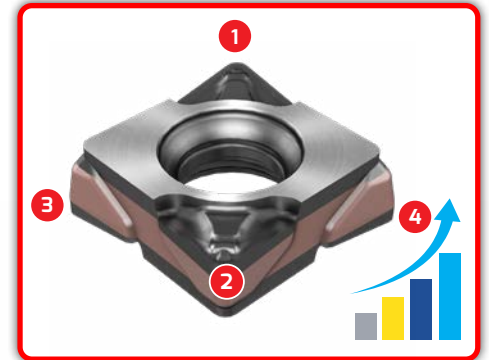

\* SCLXR / SCLXL / AVC-SCLXR / AVC-SCLXL / A...-SCLXR / A...-SCLXL ...  
The image shown is for representational purposes.

**SPECIAL  
OFFER**

**MAXVALUE**

**MINIMUM COST MAXIMUM OUTPUT**



A unique six-edged positive insert offering a **cost-effective alternative** to ISO DCMT/TCMT for semi-finishing and finish turning, **delivering more cutting edges and a lower cost per part.**

**YOU**

MACHINING

**INTELLIGENTLY?**

Use Promo Code: **T2823**

## 1 Purchase

20 inserts - D6NMG... any assortment

## Receive

Corresponding tool holder

**at a 50% Additional Discount**

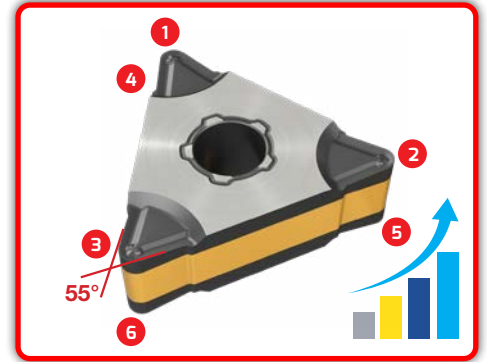

\* MTENN-W / MTJNR/L-W / PTFNR/L / DTGNR/L / PTGNR/L-X / AVC-PTLNR/L / NQCH-PTJNR/L-S-JHP / S-MTLNR/L-W / S-PTFNR/L / A-PTFNR/L-X/G..  
The image shown is for representational purposes.

**SPECIAL  
OFFER**

**MAX VALUE**

**MINIMUM COST MAXIMUM OUTPUT**



**QUICK-TURN** double-sided inserts with six cutting edges enable high-feed, multi-directional machining, boosting productivity and reducing costs.

**YOU**

**MACHINING**

**INTELLIGENTLY?**

Use Promo Code: **T2824**

**1 Purchase**

20 inserts - Q6 MNMG 12... any assortment

**Receive**

Corresponding Q6 DMXNN/R/L... tool holder\*

**at a 50% Additional Discount**

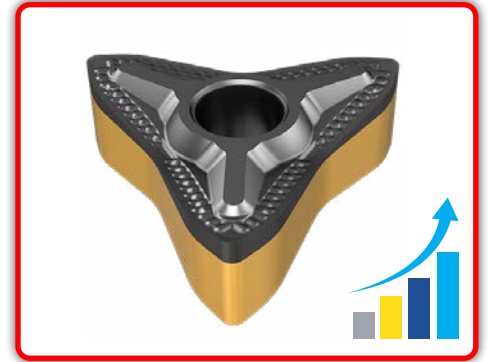

\* CAMFIX Holder is not included  
The image shown is for representational purposes.

**SPECIAL  
OFFER**

**MAXVALUE**

**MINIMUM COST MAXIMUM OUTPUT**

**MINIMUM COST**

**MAXIMUM OUTPUT**

**MORE** PERFORMANCE  
PRODUCTIVITY  
PROFITABILITY

**MAX VALUE**